

Assembly Instruction

Step 7

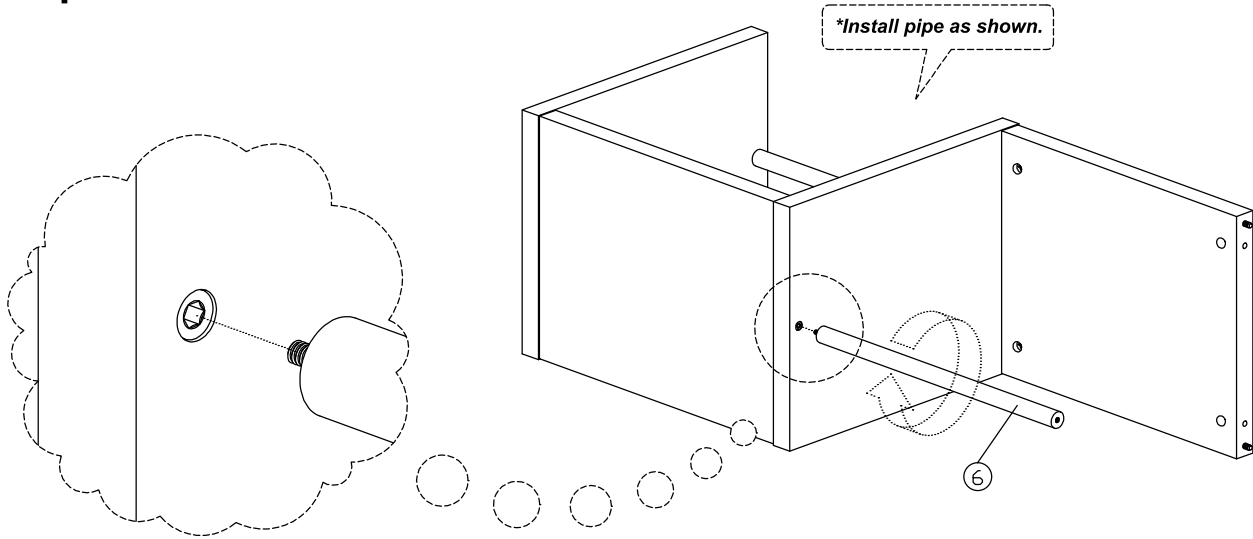

Step 8

